

Алматы (7273)495-231
Ангарск (3955)60-70-56
Архангельск (8182)63-90-72
Астрахань (8512)99-46-04
Барнаул (3852)73-04-60
Белгород (4722)40-23-64
Благовещенск (4162)22-76-07
Брянск (4832)59-03-52
Владивосток (423)249-28-31
Владикавказ (8672)28-90-48
Владимир (4922)49-43-18
Волгоград (844)278-03-48
Вологда (8172)26-41-59
Воронеж (473)204-51-73
Екатеринбург (343)384-55-89

Иваново (4932)77-34-06
Ижевск (3412)26-03-58
Иркутск (395)279-98-46
Казань (843)206-01-48
Калининград (4012)72-03-81
Калуга (4842)92-23-67
Кемерово (3842)65-04-62
Киров (8332)68-02-04
Коломна (4966)23-41-49
Кострома (4942)77-07-48
Краснодар (861)203-40-90
Красноярск (391)204-63-61
Курск (4712)77-13-04
Курган (3522)50-90-47
Липецк (4742)52-20-81

Россия +7(495)268-04-70

Магнитогорск (3519)55-03-13
Москва (495)268-04-70
Мурманск (8152)59-64-93
Набережные Челны (8552)20-53-41
Нижний Новгород (831)429-08-12
Новокузнецк (3843)20-46-81
Ноябрьск (3496)41-32-12
Новосибирск (383)227-86-73
Омск (3812)21-46-40
Орел (4862)44-53-42
Оренбург (3532)37-68-04
Пенза (8412)22-31-16
Петрозаводск (8142)55-98-37
Псков (8112)59-10-37

Казахстан +7(7172)727-132

Пермь (342)205-81-47
Ростов-на-Дону (863)308-18-15
Рязань (4912)46-61-64
Самара (846)206-03-16
Саранск (8342)22-96-24
Санкт-Петербург (812)309-46-40
Саратов (845)249-38-78
Севастополь (8692)22-31-93
Симферополь (3652)67-13-56
Смоленск (4812)29-41-54
Сочи (862)225-72-31
Ставрополь (8652)20-65-13
Сургут (3462)77-98-35
Сыктывкар (8212)25-95-17
Тамбов (4752)50-40-97

Киргизия +996(312)96-26-47

Тверь (4822)63-31-35
Тольятти (8482)63-91-07
Томск (3822)98-41-53
Тула (4872)33-79-87
Тюмень (3452)66-21-18
Ульяновск (8422)24-23-59
Улан-Удэ (3012)59-97-51
Уфа (347)229-48-12
Хабаровск (4212)92-98-04
Чебоксары (8352)28-53-07
Челябинск (351)202-03-61
Череповец (8202)49-02-64
Чита (3022)38-34-83
Якутск (4112)23-90-97
Ярославль (4852)69-52-93

www.masterwatt.nt-rt.ru | | mwa@nt-rt.ru

Технические характеристики на датчики, термодпары, терморезисторы КОМПАНИИ **MASTERWATT**

THERMOCOUPLES AND THERMORESISTANCES



THERMOCOUPLES AND THERMORESISTANCES

Thermocouples and Thermoresistances are components which are employed to measure the temperature. The Thermocouples consist of two metallic conductors, joint at one end (the so-called "junction") encapsulated into a metallic tube: if the temperature changes, the voltage that can be measured at the conductors terminals changes as well. This variation can be directly linked to the temperature that the junction is experiencing. Our produce include standard thermocouples (with grounded-junction) and mineral oxide thermocouples (with isolated junction).

Thermoresistances are components which are employed to measure the temperature but, differently from thermocouples, the sensing element is a component, located at the end of the sensor, whose electrical resistance changes with changing temperature. This variation yields a measure of the temperature that the sensing element is experiencing.

Also for thermoresistances, both the standard (conductors insulation in fibreglass-silicone) and the mineral-oxide version (insulation made of MgO compressed powder) are possible.

THERMOCOUPLES and THERMORESISTANCES

- Temperature measurement sensors for industrial use -

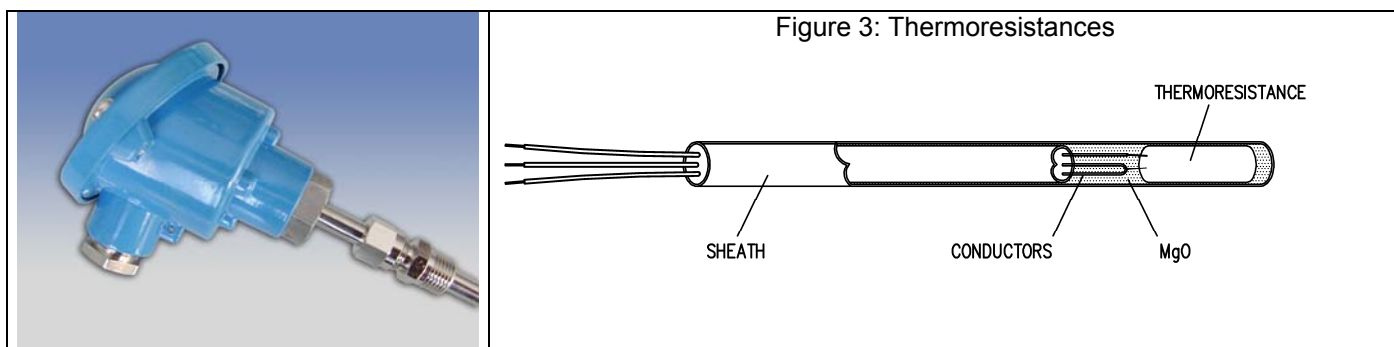
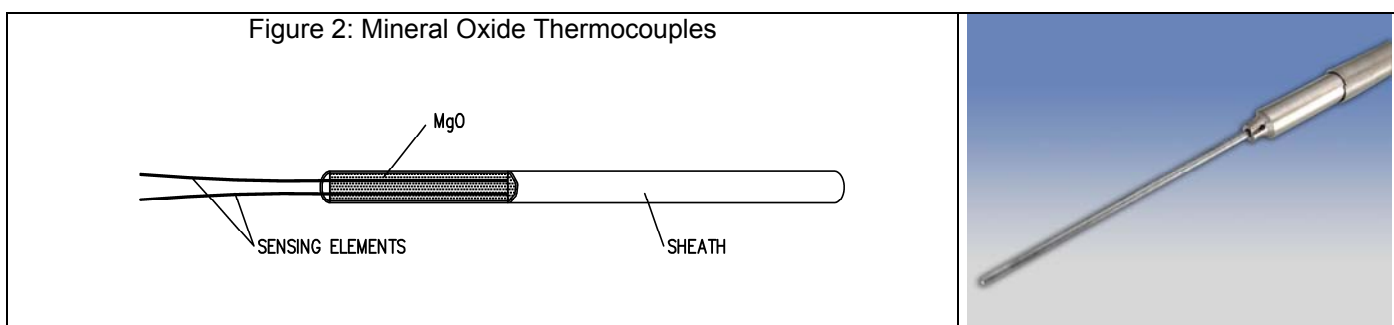
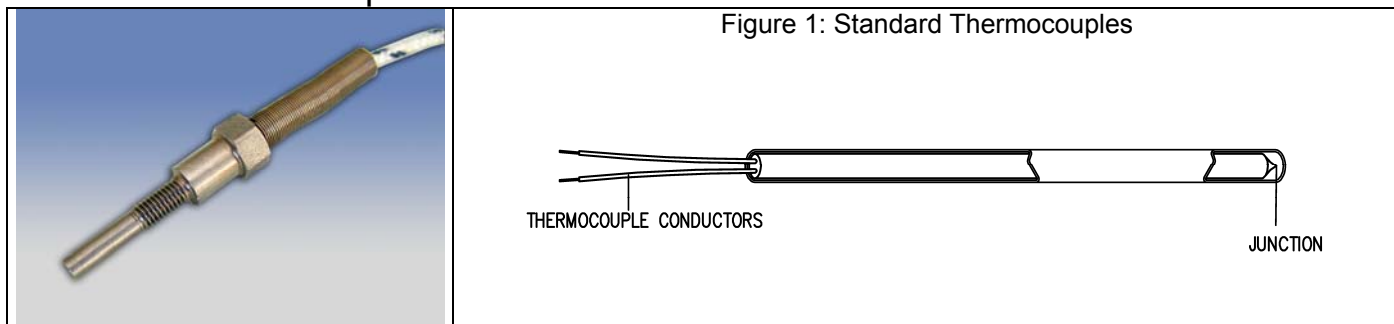

GENERAL CHARACTERISTICS

Thermocouples (Figure 1 e 2) are components which are employed to measure the temperature. They consist of two metallic conductors, joint at one end (the so-called "junction") encapsulated into a metallic tube: if the temperature changes, the voltage that can be measured at the conductors terminals (= e.m.f., electro-motive-force) changes as well. This variation can be directly linked to the temperature that the junction is experiencing. Standard thermocouples have the junction which is in direct contact with the tube sheath (grounded-junction, see Figure 4). The metallic conductors within the tube are insulated by a fibreglass-silicon sheath. Mineral oxide thermocouples junction, on the contrary, is isolated from the tube sheath (see Figure 5). The metallic conductors are annealed into a compressed MgO powder.

Also **Thermoresistances** are components which are employed to measure the temperature but, differently from thermocouples, the sensing element is a component, located at the end of the sensor, whose electrical resistance changes with changing temperature. This variation yields a measure of the temperature that the sensing element is experiencing. The standard construction for thermoresistances considers a 2-wires connection. For a better measurement accuracy, 3 or 4-wires connection are possible too (see Figure 6). Also for thermoresistances, both the standard (conductors insulation in fibreglass-silicone) and the mineral-oxide version (insulation made of MgO compressed powder) are possible.

Figure 6:

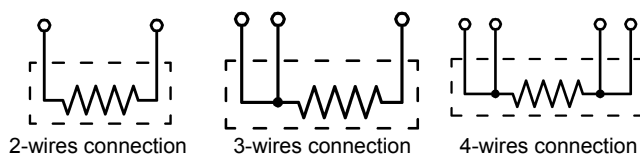

<p>Figure 4: grounded junction</p> <p>The junction of the sensing elements is made directly onto the tube sheath.</p>	<p>Figure 5: Isolated junction</p> <p>The junction of the sensing elements is electrically and mechanically isolated from the sheath. This insures a long duration even if thermal shocks or corrosive conditions are experienced</p>

The thermocouples that Masterwatt supplies are compliant to ANSI or DIN specifications. The thermoresistances fulfil IEC or DIN requirements.

APPLICATIONS

Standard Thermocouples (Figure 1) are suitable whenever severe operational conditions (i.e. vibrations, mechanical loads, pressure) are NOT present.

Mineral Oxide Thermocouples (Figure 2) are recommended in all applications where a fast response or a reduced dimension of the sensing element is required. For this type of products it is also possible to manufacture double thermocouples (i.e. thermocouples with two sensing elements inserted into the tube sheath).

Thermoresistances (Figure 3), compared to thermocouples, provide, at low temperatures, a more accurate measurement. Hence their use is recommended if the application requires a good measurement accuracy and the process temperatures do not exceed 200 °C.

TECHNICAL DATA RELEVANT TO THERMOCOUPLES

1. **CONDUCTORS** made of Iron/Constantan or in Nickel/Chrome-Nickel
2. **CONDUCTORS INSULATION** made of fibreglass-silicone (standard thermocouples) or of compressed MgO (mineral oxide thermocouples)
3. **EXTERNAL SHEATH** made of AISI 304 (other materials are possible – see catalogue)
4. **HOT JUNCTION** grounded (standard thermocouples) or isolated (mineral oxide thermocouples)
5. **OPERATING TEMPERATURE** up to 700 °C (Iron/Constantan conductors) or up to 1200 °C (Nickel/Chrome-Nickel conductors)

TECHNICAL DATA RELEVANT TO THERMORESISTANCES

1. **CONDUCTORS** made of copper
2. **CONDUCTORS INSULATION** made of fibreglass-silicone or of compressed MgO
3. **EXTERNAL SHEATH** made of AISI 304 (other materials are possible – see catalogue)
4. **SENSING ELEMENT** made of a nickel or platinum resistive winding (nominal resistance equal to 100 Ω at 0 °C)
5. **VOLTAGE SUPPLY** 2-wires (standard) or 3 or 4-wires (optional)
6. **OPERATING TEMPERATURE** from 400 °C to 700 °C depending on model (see catalogue)

STANDARD DIMENSIONS

The technical, functional and manufacturing characteristics of the thermocouples and the thermoresistances which are available on stock are detailed in the pages of this catalogue. To order these products just specify the relevant code.

SPECIAL EXECUTIONS

Upon request, thermocouples and thermoresistances which are different from the standard can be produced. The feasibility shall be assessed, case by case, by our technical department. In particular the following can be provided:

- 3 or 4-wires thermoresistances
- Double thermocouples or thermoresistances (i.e. with two sensing elements inserted within the tube sheath)
- thermocouples or thermoresistances with non standard dimensions, suitable for all applications with peculiar installation needs.

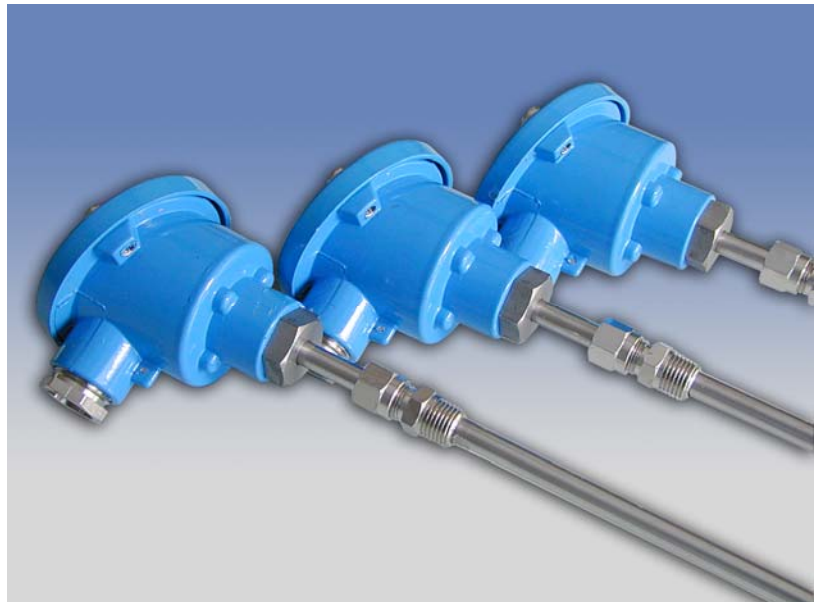

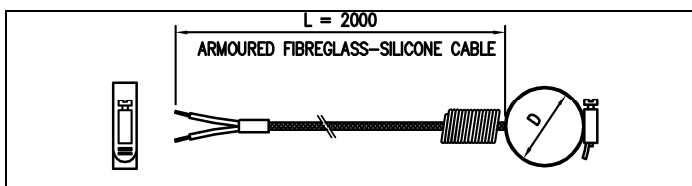

Code	Sheath Material	Sensing Element	Hot Junction	Max. temp. (°C)	D _{min} (mm)	D _{max} (mm)
TCN 2510/1	AISI 304	Fe-CuNi	grounded	-10 / +400	25	45
TCN 2510/2					48	68
TCN 2510/3					5	98

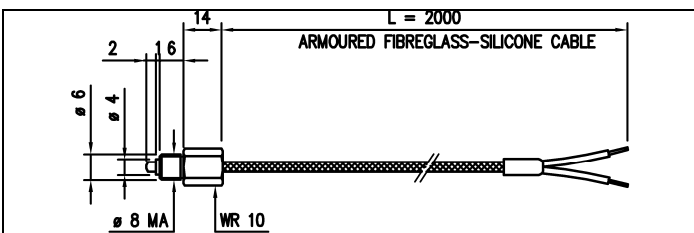

Code	Sheath Material	Sensing Element	Hot Junction	Max. temp. (°C)
TCN 2756	AISI 304	Fe-CuNi	grounded	-10 / +400

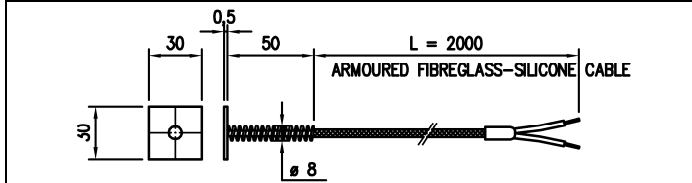

Code	Sheath Material	Plate Material	Sensing Element	Hot Junction	Max. temp. (°C)
TCN 2757	AISI 304	Brass	Fe-CuNi	grounded	-10 / +400

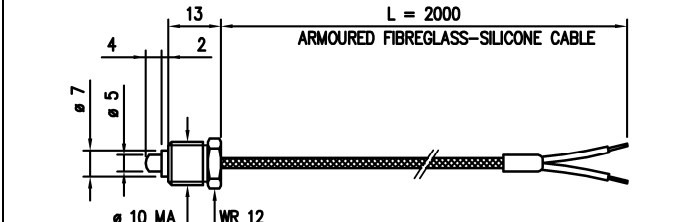

Code	Sheath Material	Sensing Element	Hot Junction	Max. temp. (°C)
TCN 2755	AISI 304	Fe-CuNi	grounded	-10 / +400

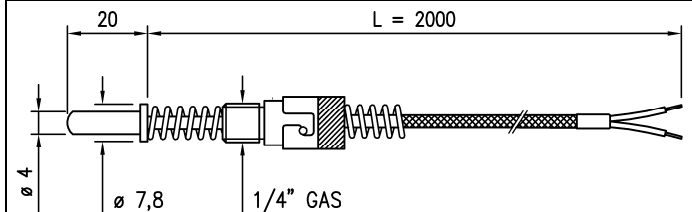

Code	Sheath Material	Sensing Element	Hot Junction	Max. temp. (°C)
TCN 2758	AISI 304	Fe-CuNi	grounded	-10 / +400

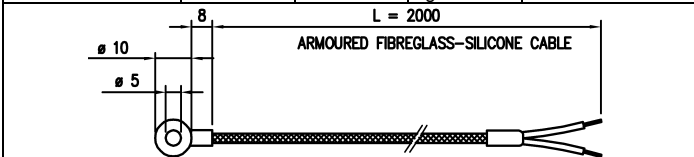

Code	Sheath Material	Type	Sensing Element	Hot Junction	Max. temp. (°C)
TCN 2753	Cu Sn	Armoured cable	Fe-CuNi	grounded	-10 / +400
TCN 2754		non armoured cable			

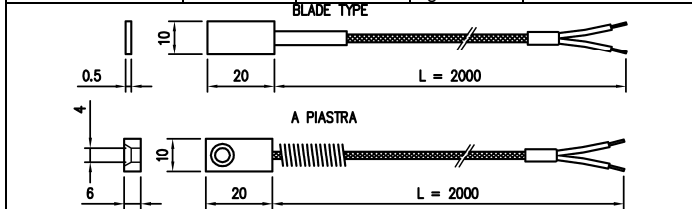

Code	Sheath Material	Type	Plate Material	Sensing Element	Hot Junction	Max. temp. (°C)
TCN 4692	AISI 304	Blade	Brass	Fe-CuNi	grounded	-10 / +400
TCN 4693		Plate				

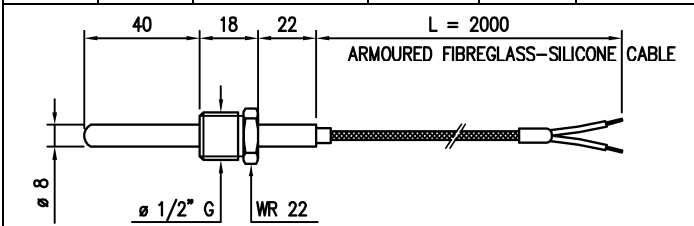

Code	Sheath Material	Sensing Element	Hot Junction	Max. temp. (°C)
TRE 3752	AISI 304	PT 100	-----	-10 / +400

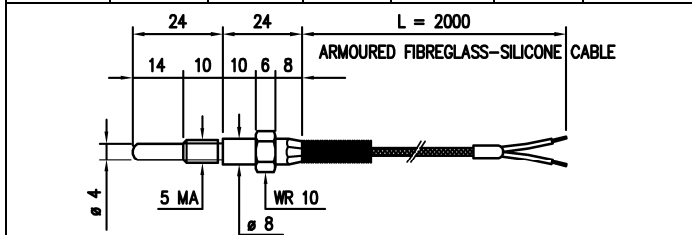

Code	Sheath Material	Sensing Element	Hot Junction	Max. temp. (°C)
TCN 1163	AISI 304	Fe-CuNi	grounded	-10 / +400

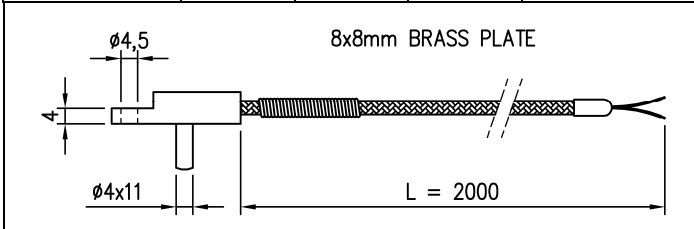

Code	Sheath Material	Sensing Element	Hot Junction	Max. temp. (°C)
TCN 0756	AISI 304	Fe-CuNi	grounded	0 / +350

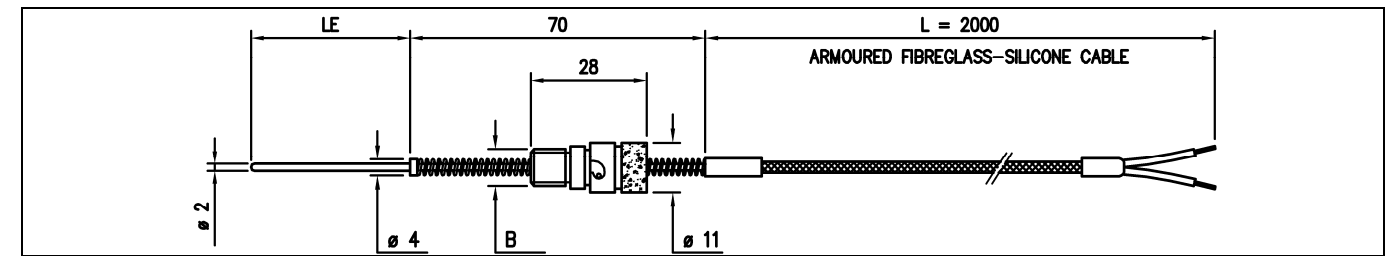

MINERAL OXIDE INSULATION THERMOCOUPLES AND THERMORESISTANCES

Code	Sheath Material	Sensing Element	Hot Junction	Max. temp. (°C)	LE	B
TCN 2759	AISI 304	Fe-CuNi	isolated	-10 / +700	0 ÷ 230	1/4" G, 12MA, 12MB
TRE 3753			-----	-10 / +600	0 ÷ 600	

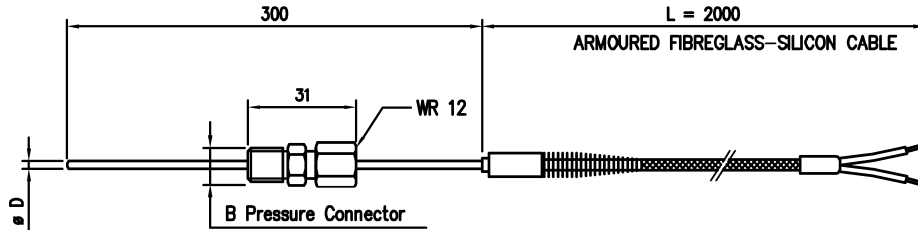

MINERAL OXIDE INSULATION THERMOCOUPLES AND THERMORESISTANCES

Code	Sheath Material	Sensing Element	Hot Junction	Max. temp. (°C)	D	B
TCN 2760	AISI 304	Fe-CuNi	Isolated	-10 / +700	2	1/4"G, 12MA, 12MB
TRE 3754		1 PT 100	-----	-10 / +600	2	

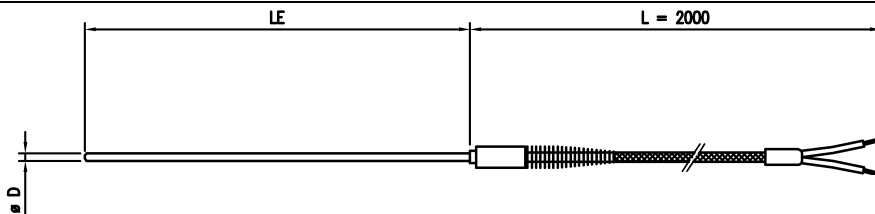

MINERAL OXIDE INSULATION THERMOCOUPLES

Code	Sheath Material	Sensing Element	Hot Junction	Max. temp. (°C)	D (mm)	LE (mm)
TCN 2710	AISI 304	Fe-CuNi	isolated	-10 / +500	1.5	50
TCN 2771						100
TCN 2772						150
TCN 2773						200
TCN 4700					2	100
TCN 4701						150
TCN 4702						200
TCN 4703						300

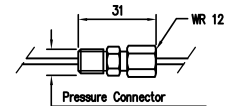

OPTIONAL CONNECTIONS

Φ D (mm)	Pressure Connector
1.5	1/8"G
2	1/4"G

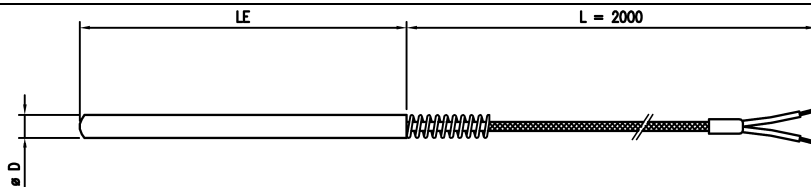

STANDARD FIBREGLASS INSULATION THERMOCOUPLES AND THERMORESISTANCES

Code	Sheath Material	Sensing Element	Hot Junction	Max. temp. (°C)	D (mm)	LE (mm)
TCN 2762	AISI 304	Fe-CuNi	grounded	-10 / +400	5	100
TCN 2764				-10 / +400	6	50
TCN 820/1				-10 / +400	6	100
TCN 820/2				-10 / +400	8	50
TCN 820/3				-10 / +400	8	100
TRE 3756				1 PT 100	-----	-10 / +300

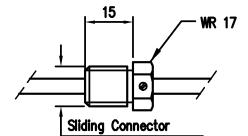

OPTIONAL CONNECTIONS

Sliding Connections
12MA

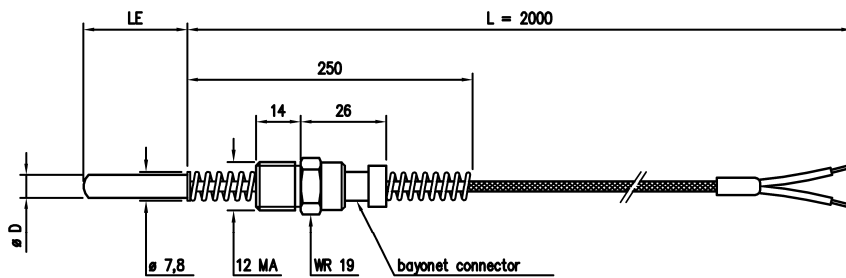

FIBREGLASS SILICONE CABLE

BAYONET COUPLING THERMOCOUPLES AND THERMORESISTANCES

Code	Sheath Material	Sensing Element	Hot Junction	Max. temp. (°C)	D (mm)	LE (mm)	Armoured	Non Armoured
TCN 2752	AISI 304	Fe-CuNi	grounded	-10 / + 400	5	15	●	
TCN 2751			isolated		6	15	●	
TCN 503			grounded		6	35	●	
TCN 2750			grounded		6	15		●
TRE 3750			1 PT 100		-----	6.5	15	●

Bayonet Connection
1/4"G
12MB

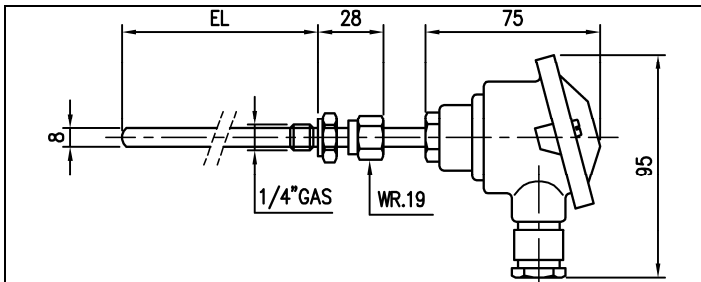

Code	Sheath Material	Sensing Element	EL	Max. temp. (°C)
TCN 2810	AISI 304	Fe-CuNi	50 ÷ 500	450
TCN 2815		Cr All		700
TRE 3765		1 PT 100		450

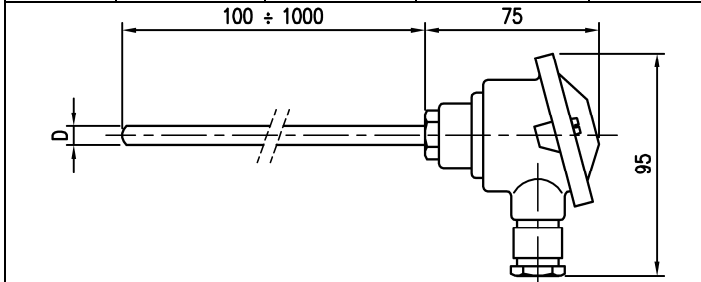

Code	Sheath Material	Sensing Element	D Ø mm	Max. temp. (°C)
TCN 2860	AISI 304	Fe-CuNi	16	750
TCN 2865	AISI 316	Fe-CuNi	16	750
TRE 3780	AISI 310	Cr All	21	1200
TRE 3785	AISI 446	Cr All	21	1200
TRE 3790	Inconel 600	Pt Rh 10 % Pt	21	1200

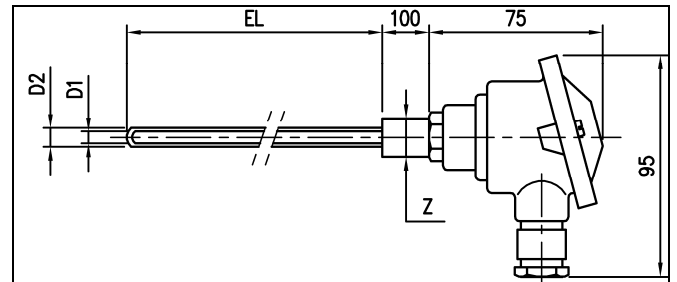

Code	Sheath Material	Max. temp (°C)	Sensing Element	D1 Ø mm	D2 Ø mm	Z mm	EL
TCN 2880	Pythag. DIN 610	750	Fe-CuNi	10	13	300	
TCN 2890	Pythag. DIN 610	1200	Cr All	15	18	500	
TRE 3800	Silim. DIN 530	1500	Pt Rh 10 % Pt	17	21	800	
TRE 3805	Alsint 9.7 DIN 710	1500	Pt Rh 10 % Pt	26	30	1000	
TCN 2895	Pythag. DIN 610	750	Fe-CuNi	10	17	21	300
TCN 2900	Pythag. DIN 610	1200	Cr All	10	17	21	500
TRE 3810	Silim. DIN 530	1500	Pt Rh 10 % Pt	16	26	30	800
TRE 3815	Alsint 9.7 DIN 710	1500	Pt Rh 10 % Pt	16	26	30	1000
TRE 3820	Alsint 9.7 DIN 710	1500	Pt Rh 10 % Pt	16	26	30	1500

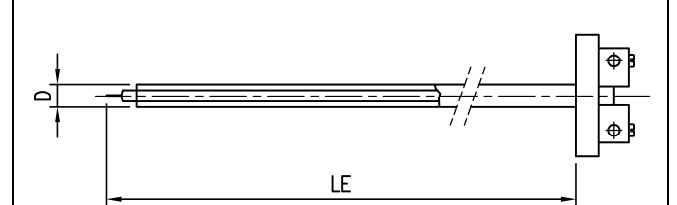

INSERTS FOR THERMOCOUPLES OR THERMORESISTANCES			
Code	Sensing Element	D Ø mm	LE
TRE 3795	1 PT 100	5.5	If requested
TCN 2870	Fe-CuNi	11.5	If requested
TCN 2875	Cr All	11.5	If requested

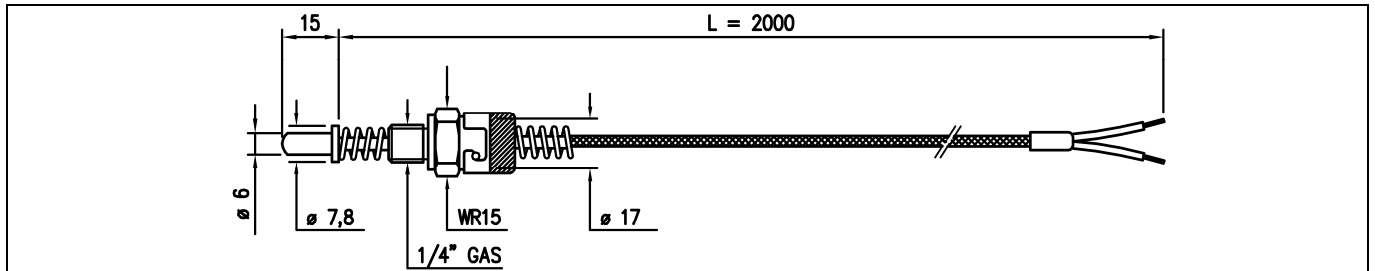

BAYONET COUPLING THERMOCOUPLES				
Code	Sheath Material	Sensing Element	Hot Junction	Max. temp. (°C)
TCN 4708	AISI 304	Fe-CuNi	isolated	0 / +350
TCN 4709			Grounded	

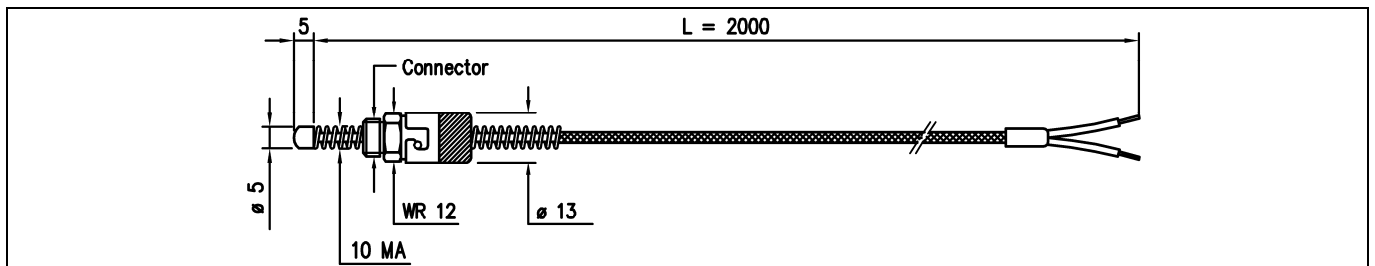

BAYONET COUPLING THERMOCOUPLES					OPTIONAL CONNECTIONS
Code	Sheath Material	Sensing Element	Hot Junction	Max. temp. (°C)	
TCN 4710	AISI 304	Fe-CuNi	isolated	0 / +350	1/8" G
TCN 4711			Grounded		

BIPOLAR EXTENSION CABLE FOR THERMOCOUPLES

Figure 7: Extension Cables

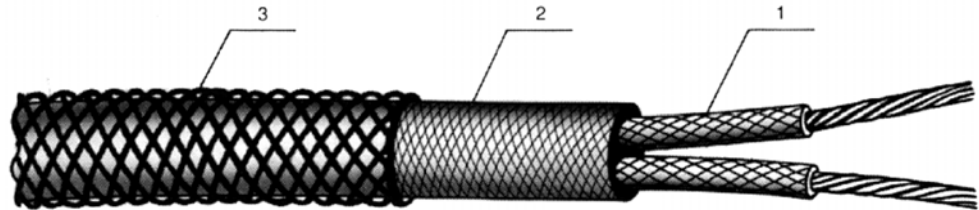

GENERAL CHARACTERISTICS

Extension cables are used to prolong the standard length of the thermocouples cables so that they can be connected to the control panel even if it is located far away from the measurement point.

They are manufactured using conductors with the same materials as those employed on the thermocouple that they have to be connected to. Thanks to this characteristic, they do not alter significantly the measurement value provided by the thermocouple.

TECHNICAL DATA RELEVANT TO EXTENSION CABLES (see Figure 7)

1. **INSULATION** made of fibreglass silicone braid
2. **EXTERNAL SHEATH** made of fibreglass silicone
3. **SHIELD** made of a braid of tinned copper wires with coverage factor 75 %
4. **OPERATING TEMPERATURE** from -60 °C to +250 °C

STANDARD DIMENSIONS

The technical characteristics of the extension cable that are available on stock are listed in Table 7.

Tables 8 and 9 provide the characteristic data of extension cables as defined in ANSI and DIN specifications.

Table 7: Extension cables available on stock

Type	Section (mm ²)	AWG	Dimensions	Code (DIN colour blue)	Code (ANSI colour black)	Type	Section (mm ²)	AWG	Dimensions	Code (DIN colour blue)	Code (ANSI colour black)
JX	2 x 0.50	20	Φ 4.2	JX 232105	JX 222105	KX	2 x 0.50	20	Φ 4.2	KX 232105	KX 222105
	2 x 0.80	18	4.5 x 2.8	JX 232108	JX 222108		2 x 0.80	18	4.5 x 2.8	KX 232108	KX 222108

Table 8: Colour Codes and Error Limits for extension cables as defined in ANSI MC 96.1 – 1975 ISA-RPI specifications

Type	Conductors		Colours			Operating Temperature	Error Limits	
	Positive	Negative	Sheath	Positive	Negative		Standard	Special
TX	Copper	Constantan	Blue	Blue	Red	-60 ÷ 100 °C	± 1.0 °C	± 0.5 °C
JX	Iron	Constantan	Nero	White	Red	0 ÷ 200 °C	± 2.2 °C	± 1.1 °C
EX	Chromel	Constantan	Violet	Violet	Red	0 ÷ 200 °C	± 1.7 °C	---
KX	Chromel	Alumel	Yellow	Yellow	Red	0 ÷ 200 °C	± 2.2 °C	---

Table 9: Colour Codes and Error Limits for extension cables as defined in DIN 43714 e DIN 43710 specifications

Type	Conductors		Colours			Operating Temperature	Error Limits
	Positive	Negative	Sheath	Positive	Negative		Standard
TX	Copper	Constantan	Brown	Red	Brown	-60 ÷ 100 °C	± 3.0 °C
JX	Iron	Constantan	Blue	Red	Blue	0 ÷ 200 °C	± 3.0 °C
KX	Chromel	Alumel	Green	Red	Green	0 ÷ 200 °C	± 3.0 °C

STANDARD CONNECTORS FOR THERMOCOUPLES

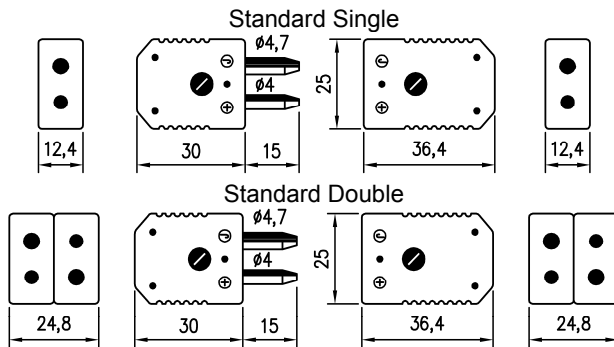

Standard Construction Characteristics

Shell Material:

 Thermoplastic: operating temperatures: $-100\text{ }^{\circ}\text{C} \div +250\text{ }^{\circ}\text{C}$
Studs Material:

Same as thermocouple material with single and multiple connectors from 2.8 mm diameter to 6 mm diameter.

Calibration: K, J, T, E

Colour Code: as per ANSI specifications

GENERAL CHARACTERISTICS

Thermocouple connectors represent the best solution to join electrically the cables of a thermocouple to their relevant extension cables. They consist of a plug (male connector) and a socket (female connector) and are available in single and double version (to be used with double thermocouples too). Mini connectors (series "Mini") are available too: they provide the same function with minimum possible envelope.

As for the extension cables, the thermocouple connectors are manufactured using the same material as the one employed on the thermocouple they are connected to. Thanks to this characteristic, they do not alter the measured value.

STANDARD DIMENSIONS

The characteristics of the connectors that are available on stock are listed in Tables 10 and 11 (standard connectors) and in Tables 12 and 13 (mini connectors).

Table 10: Thermocouple Connectors available on stock – standard series

Type	Connectors metal plugs		Colours	Code			
	Small (+)	Big (-)		Single Plug	Single Socket	Double Plug	Double Socket
K	NiCr	Ni	Yellow	01100004	01100003	01100100	01100108
J	Fe	CuNi	Black	01100009	01100008	01100101	01100109
T	Cu	CuNi	Blue	01100014	01100013	01100102	01100110
E	NiCr	CuNi	Purple	01100019	01100018	01100103	01100111

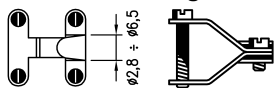
Table 11: Cable glands for thermocouples available on stock – standard series

Single connector cable gland	Code: 01410001
Double connector cable gland	Code: 01410007

MINI-CONNECTORS FOR THERMOCOUPLES

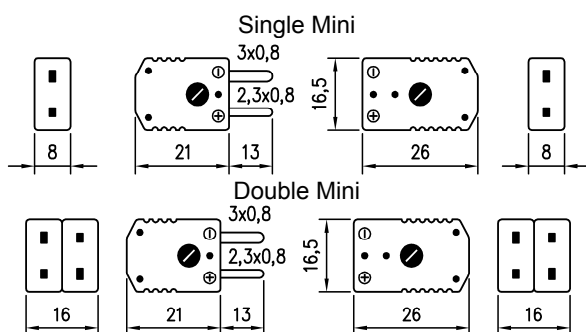

Standard Construction Characteristics

Shell Material:

 Thermoplastic: operating temperatures: $-100\text{ }^{\circ}\text{C} \div +250\text{ }^{\circ}\text{C}$
Studs Material:

Same as thermocouple material with single and multiple connectors from 0.5 mm diameter to 4 mm diameter.

Calibration: K, J, T, E

Colour Code: as per ANSI specifications

Table 12: Thermocouple Connectors available on stock – mini series

Type	Connectors metal plugs		Colours	Code			
	Small (+)	Big (-)		Single Plug	Single Socket	Double Plug	Double Socket
K	NiCr	Ni	Giallo	01100001	01100002	01100146	01100158
J	Fe	CuNi	Nero	01100006	01100007	01100147	01100159
T	Cu	CuNi	Blu	01100011	01100012	01100148	01100160
E	NiCr	CuNi	Porpora	01100016	01100017	01100149	01100161

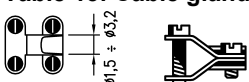
Table 13: Cable glands for thermocouples available on stock – mini series

Single connector cable gland	Code: 01410004
Double connector cable gland	Code: 01410009

Алматы (7273)495-231
Ангарск (3955)60-70-56
Архангельск (8182)63-90-72
Астрахань (8512)99-46-04
Барнаул (3852)73-04-60
Белгород (4722)40-23-64
Благовещенск (4162)22-76-07
Брянск (4832)59-03-52
Владивосток (423)249-28-31
Владикавказ (8672)28-90-48
Владимир (4922)49-43-18
Волгоград (844)278-03-48
Вологда (8172)26-41-59
Воронеж (473)204-51-73
Екатеринбург (343)384-55-89

Иваново (4932)77-34-06
Ижевск (3412)26-03-58
Иркутск (395)279-98-46
Казань (843)206-01-48
Калининград (4012)72-03-81
Калуга (4842)92-23-67
Кемерово (3842)65-04-62
Киров (8332)68-02-04
Коломна (4966)23-41-49
Кострома (4942)77-07-48
Краснодар (861)203-40-90
Красноярск (391)204-63-61
Курск (4712)77-13-04
Курган (3522)50-90-47
Липецк (4742)52-20-81

Магнитогорск (3519)55-03-13
Москва (495)268-04-70
Мурманск (8152)59-64-93
Набережные Челны (8552)20-53-41
Нижний Новгород (831)429-08-12
Новокузнецк (3843)20-46-81
Ноябрьск (3496)41-32-12
Новосибирск (383)227-86-73
Омск (3812)21-46-40
Орел (4862)44-53-42
Оренбург (3532)37-68-04
Пенза (8412)22-31-16
Петрозаводск (8142)55-98-37
Псков (8112)59-10-37

Пермь (342)205-81-47
Ростов-на-Дону (863)308-18-15
Рязань (4912)46-61-64
Самара (846)206-03-16
Саранск (8342)22-96-24
Санкт-Петербург (812)309-46-40
Саратов (845)249-38-78
Сеvastополь (8692)22-31-93
Симферополь (3652)67-13-56
Смоленск (4812)29-41-54
Сочи (862)225-72-31
Ставрополь (8652)20-65-13
Сургут (3462)77-98-35
Сыктывкар (8212)25-95-17
Тамбов (4752)50-40-97

Тверь (4822)63-31-35
Тольятти (8482)63-91-07
Томск (3822)98-41-53
Тула (4872)33-79-87
Тюмень (3452)66-21-18
Ульяновск (8422)24-23-59
Улан-Удэ (3012)59-97-51
Уфа (347)229-48-12
Хабаровск (4212)92-98-04
Чебоксары (8352)28-53-07
Челябинск (351)202-03-61
Череповец (8202)49-02-64
Чита (3022)38-34-83
Якутск (4112)23-90-97
Ярославль (4852)69-52-93

Россия +7(495)268-04-70

Казахстан +7(7172)727-132

Киргизия +996(312)96-26-47

www.masterwatt.nt-rt.ru | | mwa@nt-rt.ru